

# Schlüter®-BEKOTEC-THERM-EAHB

Actuator for adaptive hydronic balancing



## Operating instructions



## 1. Intended use

Intelligent autonomous electrothermal control 230 V NC for adaptive hydronic balancing of the heating circuits in a heating circuit distributor in BEKOTEC-THERM radiant panel heating and cooling systems. Normally closed and with folding lever for zero current opening or for zero current manual opening of the thermostat valve. With integrated supply temperature limiter.

For attachment to heating circuit distributors BEKOTEC-THERM-HVT/DE and BEKOTEC-THERM-HVP with a heating circuit spacing of at least 50 mm and for use with thermostat valve inserts of well-known manufacturers with M30 x 1.5 external threading (closed height 11.8 mm). Temperature sensors suitable for surface heating pipes made of plastic, metal or combinations thereof, with outside diameters of 10 to 20 mm.

## 2. Installation

- Fully open any existing flow indicators or balancing valves of all heating circuits or set them to maximum volume flow.
- Pull the orange folding lever to the front ("Manual" position = manually opened with zero current).
- Attach the actuator to the top of the thermostat valve with the union nut M30 x 1.5, align it with the logo facing forward and tighten it by hand.  
Note: Any installation position can be selected; the EAHB can be mounted in any position.
- Close the orange folding lever ("Automatic" position = closed with zero current, controlling the system when under current).
- Attach the temperature sensor clips at both surface heating pipes of the respective heating circuit (black-red at the supply line, black-blue at the return line).
- Connect the electric cable to the respective thermostat or power source (brown to switched outer conductor, blue to neutral conductor).

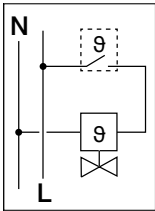

**Caution:** The device must be installed by a qualified electrician.  
All applicable safety regulations must be followed.

**Note:** *Electronically controlled heating circuit pumps must be operated in constant pressure  $\Delta p$ -c mode.*

**Note:** *Several control actuators may be connected to one thermostat.*

## 3. Automatic start-up

The EAHB will automatically activate when voltage is applied (for example, following a heat request from the thermostat). During the initialisation (determination of functional parameters), the LED will flash blue.





The initialisation takes about four minutes to complete.

Once the EAHB starts the hydronic balancing, the LED will flash green.

**Note:** *The EAHB will recognise when voltage is applied to a non-installed EAHB. The initialisation will not start. The EAHB will flash yellow. In this case, set the EAHB to zero current, install it on a thermostat valve and apply voltage again. The initialisation will then start automatically.*

The EAHB will automatically determine based on the supply temperature whether it needs to be in heating or cooling mode and will adjust the permissible set spread accordingly.

## 4. Status messages and operating conditions

| LED code   | Information  |
|--|--|
|  | Regular standard operation                             |
|  | Initialisation (see 3. and 5.) or valve flush (see 6.) |
|  | Non-attached EAHB receives current                     |
|  | Supply temperature > 60 °C (see 7.)                    |
|  | Malfunction / limited function (see 10.)               |

## 5. Manual initialisation

An EAHB unit that was mounted on a different valve must be re-initialised. This can be done manually at any time. For example, an individual EAHB can be started via the thermostat (switch from Min to Max temperature). Multiple EAHB units can be started simultaneously, e.g. via the clamping strip.

- Start: ON (<10s) → OFF → ON (<10s) → OFF → leave ON → LED will flash blue

**Note:** *The EAHB will recognise when voltage is applied to a non-installed EAHB. The initialisation will not start. The EAHB will flash yellow. In this case, set the EAHB to zero current, install it on a thermostat valve and apply voltage again. The initialisation will then start automatically.*

## 6. Flushing the valve

The thermostat valve is opened and closed completely in defined intervals to flush any accumulated contamination particles out of the flow area.

## 7. Limiting the supply temperature

If the supply temperature sensor measures a temperature > 60 °C, the EAHB will close the thermostat valve of the relevant heating circuit to prevent damage to the BEKOTEC-THERM surface heating and cooling. The LED will flash red. If the supply temperature drops below this maximum value, the EAHB will automatically revert to normal operation after a short time.

**Note:** *Limiting the supply temperature will only work if the orange folding lever is set to the "Automatic" position at the top. This function cannot replace a maximum temperature limit that safely prevents excessive temperatures in the screed (e.g. according to DIN 18560-2).*

## 8. Technical data

| TYPE                     | EAHB 230 V, NC, M 30 x 1.5   |
|--------------------------|--|
| Version                  | NC (Normally Closed)   |
| Valve connector          | Union nut M 30 x 1.5   |
| Voltage                  | 230 V AC, 50 Hz  |
| Switch-on current        | 130 mA for max. 200 ms   |
| Max. output              | 1.7 W  |
| Opening and closing time | approx. 3 min  |
| Actuating path           | ≥ 3.5 mm   |
| Actuating force          | 110 N  |
| EAHB closed height       | 10.8 mm  |
| Valve closed height      | 11.8 mm  |
| Media temperature        | 10 to 60 °C (supply temperature limiting is activated in the Automatic position) |
| Storage temperature      | -25 to 60 °C   |
| Ambient temperature      | 0 to 50 °C   |
| Relative humidity        | 10 to 100 %, non-condensing  |
| Protection rating/class  | IP 54 / II   |
| Installation position    | Can be installed in any position   |
| Connection cable         | Flexible, black, 1 m with ferrules   |
| Supply line sensor cable | Flexible, black with red stripe, 0.4 m   |
| Return line sensor wire  | Flexible, black with blue stripe, 0.4 m  |
| Temperature sensors      | NTC 10k (at 25 °C), clip for outer pipe diameter 12 to 20 mm                     |

## 9. Dimensions in mm

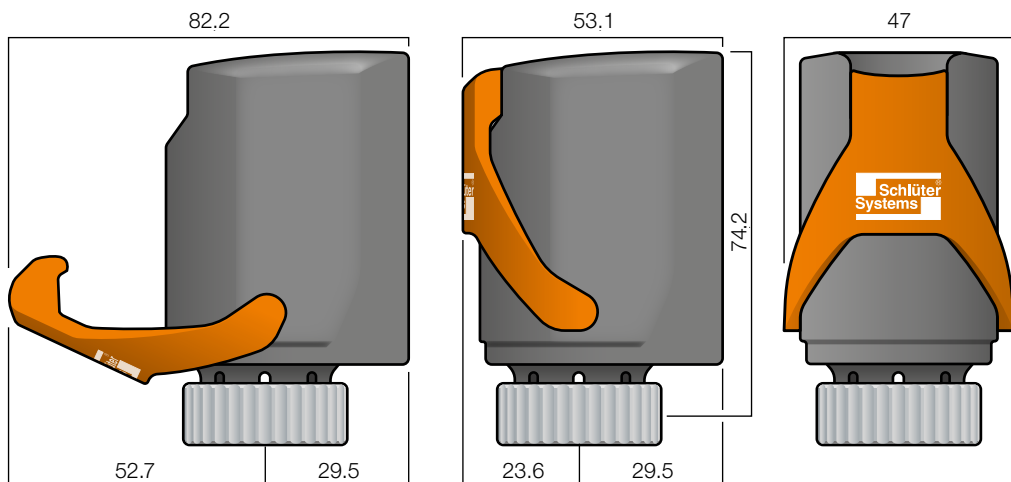

## 10. Troubleshooting

The LED will flash red if the system control is significantly affected by a malfunction. The EAHB will switch to emergency operation mode and attempt to keep the thermostat valve open to enable continued heating. Manual initialisation (see 5.) may be able to resolve the problem.

**Note:** Once the cause of the malfunction has been resolved, the EAHB will automatically revert to normal system operation after a short time. The LED will go back to flashing green.

If the problem cannot be resolved, the EAHB must be replaced.

### General problems associated with surface heating and cooling systems:

- **Flow noises**
  - Reduce pump output. If that is impossible, throttle the balancing valve until the noise stops
- **Knocking, tapping or vibration at the thermostat valve**
  - Supply line and return line switched at the distributor on the pipe side. Check and correct the connection if applicable.
- **Rooms are inadequately heated**
  - Adjust supply temperature to heat demand.
  - Check power supply for EAHB.
  - Set pump to operating mode  $\Delta p$ -c constant pressure and reset pump pressure.
  - Check thermostat and set a higher room temperature if applicable.
  - Check system flow, repeat venting of heating circuits if applicable.



This product may not be disposed of in household waste.

Please discard in special facilities for electronic waste.

## Manufacturer:

Schlüter-Systems KG · Schmölestraße 7 · D-58640 Iserlohn · www.schlueter.de

### Content

#### 1. General

|  |   |
|--|---|
| 1.1 Can the EAHB periodically open the thermostat valve in summer mode to prevent it from getting stuck? ..... | 8 |
| 1.2 Can I determine the cause of the malfunction when an EAHB is defective? .....                              | 8 |
| 1.3 Does the EAHB help save energy? .....  | 8 |
| 1.4 Can the EAHB be used for surface cooling in addition to surface heating? .....                             | 8 |
| 1.5 Can I use the EAHB exclusively for surface cooling? .....  | 8 |
| 1.6 Where can I find the version number? .....   | 8 |
| 1.7 What does the closed height of 10.8 mm for the EAHB mean? .....  | 8 |

#### 2. Installation

|  |   |
|--|---|
| 2.1 Is the EAHB suitable for use with all thermostats? .....                       | 9 |
| 2.2 Can I use the EAHB without a thermostat? .....                                 | 9 |
| 2.3 Which thermostats can be used for cooling? .....                               | 9 |
| 2.4 Can I switch previously installed EAHB units to other heating circuits? .....  | 9 |
| 2.5 Are there adjustable components of the EAHB that must or can be set? .....     | 9 |
| 2.6 How do I connect the EAHB to power? .....                                      | 9 |
| 2.7 Can the EAHB be operated with a return temperature limiter (RTB or RTL)? ..... | 9 |

#### 3. Components

|   |    |
|---|----|
| 3.1 Can I extend the temperature sensor cables on my own? .....   | 10 |
| 3.2 Does the EAHB have a stepper motor to position the valve lift? .....  | 10 |
| 3.3 Are there adapters for thermostat valve inserts that have no M30 x 1.5 connection thread? ...                   | 10 |
| 3.4 What is the purpose of the lever? .....   | 10 |
| 3.5 Can the permanent mechanical tension after attachment to the heating pipe damage the temperature sensors? ..... | 10 |

#### 4. Function

|  |    |
|--|----|
| 4.1 Which factors affect the cycle time for opening and closing? .....   | 10 |
| 4.2 How does the EAHB control work when the temperature spread is 0 K? .....   | 10 |
| 4.3 Does the EAHB always open the thermostat valve completely when the thermostat requests heating or cooling? ..... | 11 |
| 4.4 Does the EAHB always control the system based on a fixed set temperature spread? .....                           | 11 |
| 4.5 How are the water volumes adjusted? .....  | 11 |
| 4.6 What is the permissible range for the temperature spreads? .....   | 11 |
| 4.7 Is the EAHB still functional if it no longer receives any current from the thermostat? .....                     | 11 |
| 4.8 How does the EAHB save important operating parameters when it is shut off by the thermostat? .....               | 11 |
| 4.9 How does the maximum temperature limiter work? .....   | 11 |

|      |   |    |
|------|---|----|
| 4.10 | How does the EAHB control the system if the temperature sensors were swapped? .....                         | 11 |
| 4.11 | What happens if a temperature sensor becomes detached from the pipe or was inadvertently not attached?..... | 12 |
| 4.12 | Is the correct allocation of temperature sensors to the supply line and return line mandatory? .....        | 12 |
| 4.13 | How does the EAHB know whether to work in heating or cooling mode? .....                                    | 12 |

## 5. Hydronics

|     |   |    |
|-----|---|----|
| 5.1 | Is the installation of string control valves or other adjustment features required in the distribution network? ..... | 12 |
| 5.2 | Are flow indicators still required in combination with the EAHB? .....  | 12 |
| 5.3 | Can the EAHB control the hydronic balancing during functional or initial curing? .....                                | 12 |
| 5.4 | What does "learning" mean? .....  | 12 |
| 5.5 | What does adaptive hydronic balancing mean? .....   | 13 |

## 6. Initialisation

|     |   |    |
|-----|---|----|
| 6.1 | What happens during initialisation? .....             | 13 |
| 6.2 | What happens during manual initialisation? .....      | 13 |
| 6.3 | Is initialisation also triggered automatically? ..... | 13 |
| 6.4 | How long does the initialisation take?.....           | 13 |

## 7. LED flashing

|     |   |    |
|-----|---|----|
| 7.1 | Although the EAHB is not mounted on a valve insert, it flashes green or blue when it receives voltage. Why? ..... | 13 |
| 7.2 | Although the EAHB is not mounted on a valve insert, it flashes yellow when it receives voltage. Why? .....        | 14 |
| 7.3 | What is going on with the EAHB when it flashes red in regular intervals and indicates "malfunction"? .....        | 14 |

## 8. Flushing

|     |   |    |
|-----|---|----|
| 8.1 | When and how is the flush function activated? .....           | 14 |
| 8.2 | Does a manual initialisation affect the flush interval? ..... | 14 |

## 1. General

### 1.1 Can the EAHB periodically open the valve in summer mode to prevent it from getting stuck?

This question only applies to exclusive heating operation. The EAHB can only open the valve if it receives current from the thermostat. This means periodic automatic opening is an option in combination with thermostats that have a valve protection function, such as the Schluter-BEKOTEC-THERM and DITRA-HEAT-E thermostats. If the thermostats do not have this special function, we recommend opening the EAHB manually with the lever during the summer.

### 1.2 Can I determine the cause of the malfunction when an EAHB is defective?

We can read the internal memory. The history data can provide information about the cause of the malfunction.

### 1.3 Does the EAHB help save energy?

The EAHB helps minimise energy use. Based on the unit's adaptive control of heating water volumes, i.e. the adaptation to actual demand, the water volume is lower than in systems with static or dynamic balancing. That saves pump energy. Compared to systems with poor or no balancing, the energy savings are considerable. See also question 5.5.

### 1.4 Can the EAHB be used for surface cooling in addition to surface heating?

Yes. Adaptive hydronic balancing can also involve cooling water in the summer.

### 1.5 Can I use the EAHB exclusively for surface cooling?

No. Heating operation in the cold months is necessary for "learning" the hydronic minimum position. See also question 5.4. If the EAHB is first used in the summer for cooling, the hydronic balancing will not yet be fully optimised.

### 1.6 Where can I find the version number?

The version number is located on the underside of the EAHB. It starts with the letter 'V', followed by 3 numerals. See also question 1.4.

### 1.7 What does the closed height of 10.8 mm for the EAHB mean?

The closed height refers to the distance between the upper edge of the valve pin and the contact surface of the actuator/EAHB at a closed thermostat valve. It is 11.8 mm for most commercial valves. For the EAHB, this measure is taken between the positioning edge (located under the union nut) and the pressure piece (on the inside, where the valve pin will be found later). The measure is 1.0 mm smaller than for most commercial valves. This ensures that the valve can be closed in all cases, even if there are permissible production tolerances in the distribution bar, the valve insert, the connection nipple and the EAHB. See also question 7.2.



## 2. Installation

### 2.1 Is the EAHB suitable for use with all thermostats?

The EAHB works with all thermostats such as BEKOTEC-THERM or DITRA-HEAT-E thermostats (230 V, 50 Hz, ON and OFF). All designs (bimetal, relay or semiconductor as a switching component), any switch hysteresis and any control characteristic (PI or PWM) is feasible. The controls may overlap with very short switching intervals (below approx. 3 min.). Switching intervals that are shorter than 10 seconds lead to manual initialisation. Such short intervals are therefore unsuitable for the EAHB.

### 2.2 Can I use the EAHB without a thermostat?

Yes, but in that case, the EAHB will not have information about the length of the heating request (and indirectly, the current heat demand) of the corresponding room. This information has/would have an impact on the set spread. However, hydronic balancing will occur at all times even without a thermostat. See also question 5.3.

### 2.3 Which thermostats can be used for cooling?

You can use any type of thermostat, such as the BEKOTEC-THERM thermostat, that is capable of both activating the EAHB voltage in case of overly low room temperature (heating operation) and in case of overly high room temperature (cooling operation). See also question 2.1.

### 2.4 Can I switch previously installed EAHB units to other heating circuits?

Yes, provided the EAHB units have not yet been supplied with voltage (which means they have not yet been initialised). If the unit has already been initialised, you have to manually repeat the initialisation at the "new" thermostat valve insert after the switch (see operating instructions).

### 2.5 Are there adjustable components of the EAHB that must or can be set?

No, the EAHB is programmed for the physical conditions of surface heating and cooling systems. No further settings are required.

### 2.6 How do I connect the EAHB to power?

In the same way as regular actuators. The electrical connection to the thermostat is typically created with a clamping strip. However, there are no special requirements.

### 2.7 Can the EAHB be operated with a return temperature limiter (RTB or RTL)?

The EAHB is not suitable for high-temperature supply water over 60°C that typically flows into an RTL. The integrated maximum temperature limiter would close the valve.

See also question 4.9.

An RTL throttles the volume flow at the heating circuit valve when the current return temperature approximates the fixed return temperature value or closes the valve when the fixed return temperature value is exceeded. Since the EAHB works with variable spreads, it would also treat the return temperature as variable. That would not necessarily cause a limitation or interruption of the heating volume flow, which means there would be a risk of exceeding the surface temperature.

## 3. Components

### 3.1 Can I extend the temperature sensor cables on my own?

No. The use of extensions or clamps could cause disruptions that may interfere with the proper function of the EAHB.

### 3.2 Does the EAHB have a stepper motor to position the valve lift?

No, it functions with an expansion element in the manner of a conventional electrothermal actuator. This is supplemented by a distance measuring system to precisely move to and hold specific valve positions.

### 3.3 Are there adapters for thermostat valve inserts that have no M30 x 1.5 connection thread?

Various adapters are available from system retailers (for example, Heimeier thermostat head adapter M30 x 1.5 for thermostat valves Danfoss RAVL Ø 26 mm and RAV Ø 34 mm, Herz M28 x 1.5, Vaillant Ø 30 mm and Oventrop M30 x 1.0).

### 3.4 What is the purpose of the lever?

Folding the lever forward manually opens the thermostat valve. That means the water will flow, regardless of whether the EAHB is under voltage. In this lever position, the EAHB can be mounted on a valve insert without force. The lever compresses the powerful spring inside the EAHB, which keeps the thermostat valve closed in zero-current condition.

### 3.5 Can the permanent mechanical tension after attachment to the heating pipe damage the temperature sensors?

The plastic material can withstand this application and does not contain any plasticisers that may become volatile. It has a melting temperature over 170 °C. The heat distortion temperature (1.80 MPa) is above 100 °C. The typical temperature spectrum of the clip at the pipe is below 60 °C .

## 4. Function

### 4.1 Which factors affect the cycle time for opening and closing?

The cycle time is driven by the heat demand of the room. It is specified by the control settings of the thermostat, independent of the EAHB. For example, wireless or PWM thermostats such as Schluter-BEKOTEC-THERM and DITRA-HEAT-E thermostats can cause very short cycles between ON and OFF.

### 4.2 How does the EAHB control work when the temperature spread is 0 K?

The EAHB in this case cyclically opens a specific lift to guarantee the flow of water. It responds to temperature changes at the sensors. The hydronic balancing restarts when the unit detects a spread that is meaningful for heating or cooling operation. The sensors will measure the same supply leg and return leg temperatures if the sensors were not attached to the pipes, the heat generator is turned off, there is no water in the heating system or the pump is not running.

#### **4.3 Does the EAHB always open the thermostat valve completely when the thermostat requests heating or cooling?**

No, it will only open the valve up to a variable position, which it will either hold based on the calculated set value or change in the control process. The valve will not be opened completely even if the heating or cooling load to be provided is larger than the design load.

#### **4.4 Does the EAHB always control the system based on a fixed set temperature spread?**

No, the set spread is variable. The EAHB adjusts it to the corresponding supply temperature and evaluates the history data (e.g. heating times) for calculation.

#### **4.5 How are the water volumes adjusted?**

The EAHB will open or close the thermostat valve just enough to reach the calculated spread with the right amount of water flow. For this purpose, the electrothermal EAHB expansion element is able to assume and hold any lift position at the valve insert between its open and closed condition.

#### **4.6 What is the permissible range for the temperature spreads?**

We allow temperature spreads from 2 to 8 K. See also question 4.4.

#### **4.7 Is the EAHB still functional if it no longer receives any current from the thermostat?**

Just like conventional NC actuators, the EAHB will close the thermostat valve in zero current mode. The control requires power.

#### **4.8 How does the EAHB save important operating parameters when it is shut off by the thermostat?**

The energy required for saving data is stored in a capacitor. This energy is used to write the data to the non-volatile memory in the moment the voltage is interrupted. The remaining energy is then discharged in the capacitor (LED will briefly flash green and then go out).

#### **4.9 How does the maximum temperature limiter work?**

If one of the two temperature sensors measures a value  $> 60\text{ }^{\circ}\text{C}$ , the EAHB will close the valve for 15 minutes. After that period, the unit reopens the valve and checks the temperature values again.

#### **4.10 How does the EAHB control the system if the temperature sensors were swapped?**

In this case, the return temperature would be the lead value for "learning" and for calculating the set spread. That would make proper hydronic balancing impossible. See also questions 4.12 and 5.4.

#### **4.11 What happens if a temperature sensor becomes detached from the pipe or was inadvertently not attached?**

In this case, the control behaviour would be as described under question 4.10. An oversupply or undersupply situation in a heating circuit will not result in proper hydronic balancing, which is evident to the user and can be addressed.

#### **4.12 Is the correct allocation of temperature sensors to the supply line and return line mandatory?**

Yes, absolutely. The temperature value at the supply line sensor is needed for the proper calculation of the set spread and for "learning". See also questions 4.10 and 5.4.

#### **4.13 How does the EAHB know whether to work in heating or cooling mode?**

The EAHB receives this information exclusively via the temperature measured at the red-black supply line sensor. The value is used to calculate the permissible set spread range. The EAHB does not need an external "switch-over signal".

## **5. Hydronics**

#### **5.1 Is the installation of string control valves or other adjustment features required in the distribution network?**

This may be necessary depending on the hydronic properties of the distribution network. The EAHB hydronically adjusts the surface heating circuits of a distributor and is not suitable for the hydronic balancing of multiple heating circuit distributors or heating strings.

#### **5.2 Are flow indicators still required in combination with the EAHB?**

No, according to EN 1264-4, control valves or simple shut-off valves would also be sufficient. However, the display shows the water flow in operation. The flow indicators remain fully open in heating or cooling mode and do not need any further pre-settings.

#### **5.3 Can the EAHB control the hydronic balancing during functional or initial curing?**

In those situations, the thermostats either don't exist yet or they are set to the highest set temperature. That means the EAHB is under constant voltage. The EAHB recognises this special operating mode. If it has not yet been trained, it will simulate the cyclical shut-off in the same way that would occur with a thermostat in normal operation. Although the hydronics are not yet ideally controlled, the hydronic balancing occurs at all times. Once the learning process is complete, the EAHB will perfectly control the hydronics in continuous system operation.

#### **5.4 What does "learning" mean?**

After the initialisation (see also question 6.1), the distance measuring system has to determine the position at which the thermostat valve will begin to let water flow. That is called the hydronic minimum position. The more precisely the EAHB knows this position, the smaller the volume flows it can manage. This optimises the hydronic balancing. Learning occurs automatically during heating operation and does not interfere with it.

## 5.5 What does adaptive hydronic balancing mean?

In the case of static or dynamic hydronic balancing the calculated volume flows are set as fixed values at the corresponding adjustment valves. In contrast, adaptive hydronic balancing involves need-based adjustment of volume flows, which is automatically adapted to fluctuating system operating conditions.

## 6. Initialisation

### 6.1 What happens during initialisation?

The EAHB has an integrated distance measuring system that enables it to move to defined opening positions. These depend on the valve on which the unit is installed. During initialisation, the EAHB will save the position, in which the valve is (mechanically) completely closed (lowest reachable distance point on this valve).

### 6.2 What happens during manual initialisation?

The heating circuit-specific operating data learned in the last initialisation will be deleted and the EAHB starts as it would after a factory reset. Important history data will not be deleted.

### 6.3 Is initialisation also triggered automatically?

Yes, in three cases:

- a) when the EAHB is operated for the first time
- b) when the EAHB is removed from the valve insert after completed initialisation and voltage is applied to it in this (cold) condition (indicated by yellow flashing)
- c) when the lowest valve position saved during initialisation has changed (for example by "setting" the valve gasket).

### 6.4 How long does the initialisation take?

The process is completed as soon as the LED starts to flash blue. However, the blue flashing will continue for another 4 minutes to give the installer enough time to verify proper initialisation in case of manual initialisation, for example at the thermostat.

## 7. LED flashing

### 7.1 Although the EAHB is not mounted on a valve insert, it flashes green or blue when it receives voltage. Why?

A unit that is not mounted and has a closed lever should be flashing yellow. Green or blue flashing indicates that the EAHB received voltage shortly before. It therefore still has a warm expansion element, which causes the EAHB to still be "open". It therefore presumes that it is mounted on a valve. In this case, set the EAHB to zero voltage for at least 5 minutes. This time is sufficient for the expansion element to cool down and the EAHB will "close". The unit will now flash yellow when it receives voltage.

## **7.2 Although the EAHB is not mounted on a valve insert, it flashes yellow when it receives voltage. Why?**

A unit that is mounted on a valve and has a closed lever should be flashing blue or green. Yellow flashing indicates that the valve pin is not long enough to reach the pressure piece of the EAHB. The closed height of this valve is most likely smaller than 10.8 mm. Please contact our technical department for a solution.

## **7.3 What is going on with the EAHB when it flashes red in regular intervals and indicates "malfunction"?**

This indicates a function-relevant hardware problem (e.g. a broken sensor cable, a defective circuit board, expansion element or distance measuring system), which prevents the performance of hydronic balancing. If the power supply to the expansion element and the element itself are intact, the EAHB will function as a regular actuator and will open the heating circuit in response to heat requests. This maintains an "emergency operation" for room heating, which prevents cooling or freezing of system areas, especially in the winter. You can attempt to resolve the problem with a manual initialisation (see operating instructions). If that attempt fails, the EAHB must be replaced.

# **8. Flushing**

## **8.1 When and how is the flush function activated?**

The EAHB has a sum meter for its opening times. The flush function is activated every 55 hours. When it is activated, the flush is performed in the next control cycle. The EAHB will flash blue for 4 minutes during flushing.

## **8.2 Does manual initialisation affect the flush interval?**

Manual initialisation does not affect the interval since the sum meter for the opening times will continue to run without interruption.





**Schlüter-Systems KG** · Schmölestraße 7 · D-58640 Iserlohn  
Tel.: +49 2371 971-0 · Fax: +49 2371 971-1111 · [info@schlueter.de](mailto:info@schlueter.de) · [bekotec-therm.de](http://bekotec-therm.de)